

Die Steels and Components for Extrusion

COLD WORK

PLASTIC MOULDING

HOT WORK

HIGH PERFORMANCE STEEL



This information is based on our present state of knowledge and is intended to provide general notes on our products and their uses. It should not therefore be construed as a warranty of specific properties of the products described or a warranty for fitness for a particular purpose.

Contents

Uddeholm—your tooling partner	4
Uddeholm hot work tool steel for extrusion tooling	4
Tooling components in an extrusion press	5
Tool steel properties for extrusion dies and tooling	6
Material selection for dies and extrusion tooling parts	8
Manufacturing of dies and tooling	12
Product programme	13
Extrusion tooling components from HVM AB	14
Steels and hardness selection	<i>flap</i>

This information is based on our present state of knowledge and is intended to provide general notes on our products and their uses. It should not therefore be construed as a warranty of specific properties of the products described or a warranty for fitness for a particular purpose.

*We are more
than just another
steel supplier!*

Uddeholm is your tooling partner
also in the extrusion industry.

Our long experience in making,
shaping and treating the steel is your
guarantee for success.

We have developed steel grades
that can operate with optimal result
under different conditions for low
temperature aluminium extrusion
approx. 400° C (750° F) to steel extru-
sion 1250° C (2280° F).

Uddeholm—your tooling partner

The production base of the Uddeholm company is tool steel; however, our business idea is to sell and market tooling materials and services to tool makers, tool users, machine builders, and their customers, providing the best *total economy*.

Steel for industrial tools must be of very high quality. This is the primary guarantee that the parts the tool is ultimately to produce meet specified requirements. In this context, we maintain that there is a difference between steel and steel; most of our grades are unique to the market—that is why we use our own brand names—and have been developed over the years by our experienced engineers and metallurgists.

However, a first-class tool steel goes only part of the way to providing an optimum solution for a tool user. Hence, Uddeholm's present-day offer stretches beyond that of the traditional steel supplier and includes a wide range of complementary services aimed at ensuring that tool users really get the best from our tool-material products. In liaison with tool makers, tool users and, in some instances, even end users (i.e. those who use the parts which the tool shall make), we aim to develop complete solutions for optimal economy, of which the supply of the tool material is only one facet. In practical terms, this means that apart from the tooling material and associated know-how, we can in many cases offer services such as machining, heat treatment and even possibilities to assist in tool maintenance and repair e.g. welding service. We are convinced that our policy of supplying services over and above the tooling material is necessary if our customers, particularly tool users and end users, are to enjoy the best tooling economy in their production. In these times when escalating production costs cannot always be covered by increased prices, then getting the most out of tooling is often a vital ingredient in attaining viable production economy.

Uddeholm hot work tool steels for extrusion tooling

Uddeholm hot work tool steels for the manufacture of tools and components in extrusion presses:

IMPAX SUPREME
ALVAR 14
ORVAR 2 Microdized
QRO 90 SUPREME
HOTVAR
DIEVAR

with different characteristics suitable for:

- mandrels
 - mandrel holders
 - stems
 - dummy blocks
 - liners
 - intermediate liners
 - mantles
 - dies
 - die rings
 - bolsters
 - wedge blocks.
- } *containers*

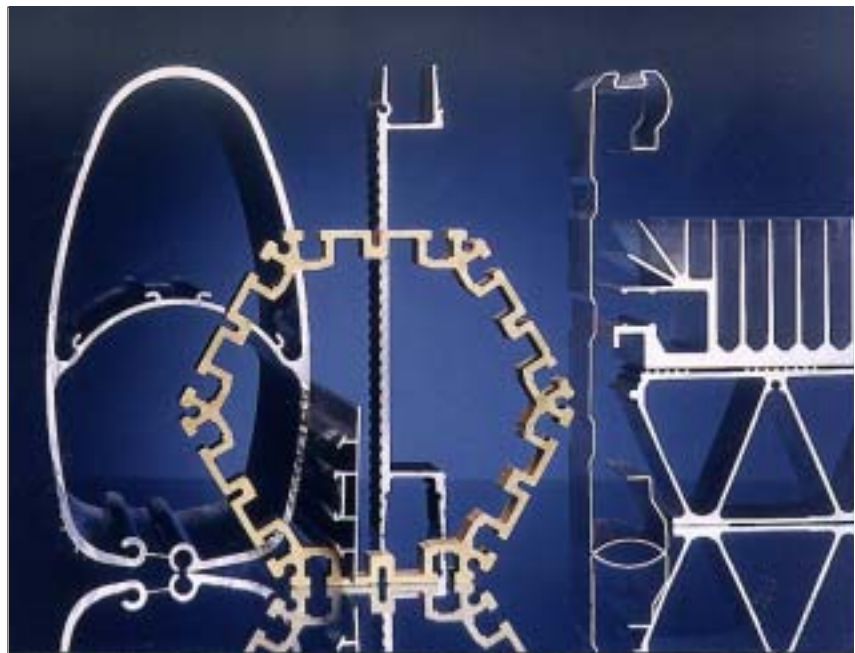

Profiles (SAPA, Sweden).

Tooling components in an extrusion press

In addition to the die itself, an extrusion press comprises a number of replaceable components with finite life, most of which are made from hot work tool steel.

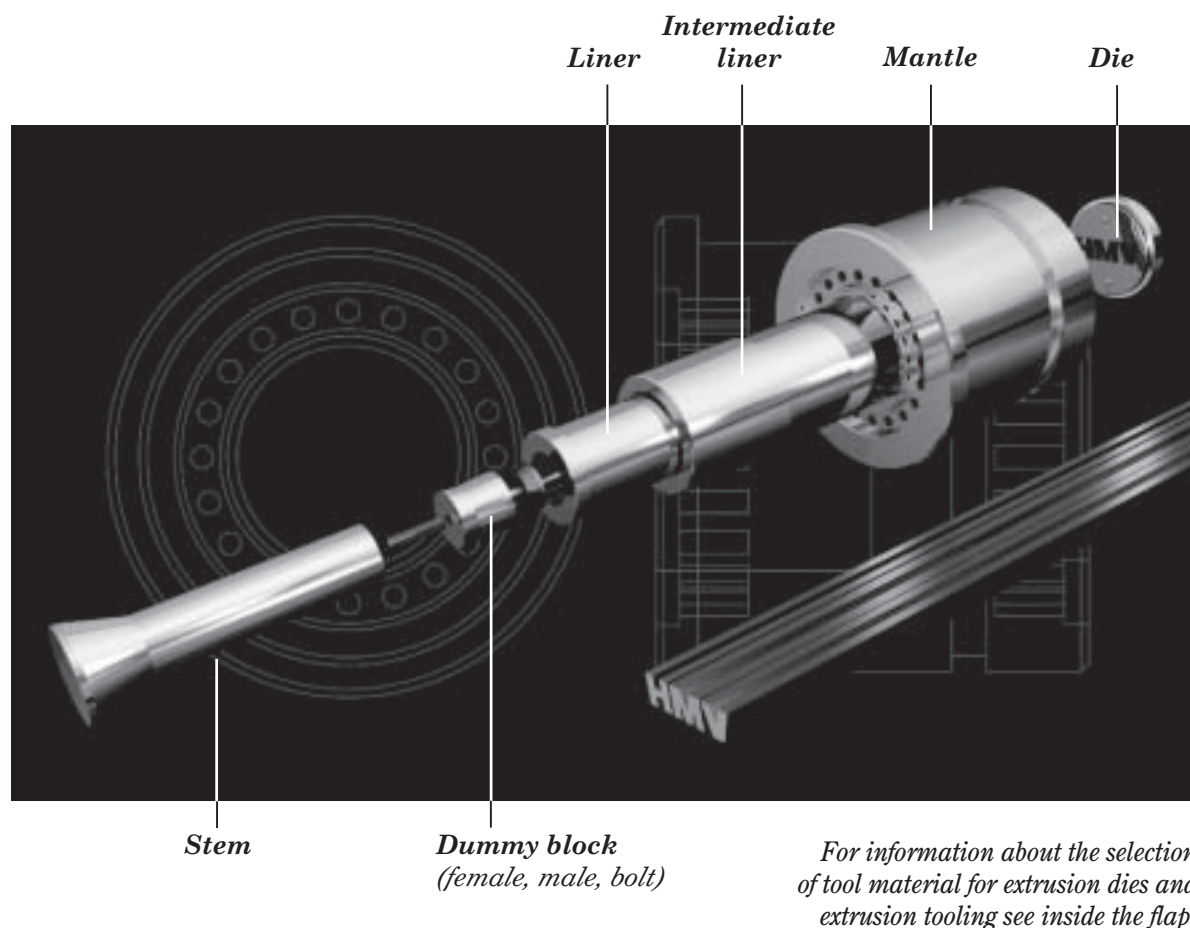

Uddeholm have long experience in producing hot work tool steels for dies and extrusion tooling components. The demands on the tool steel depend on the overall working temperature, i.e. on the metal being extruded, and on the location of the component in question in relation to the hot billet and the emerging extruded profile. The component which is subjected to the most severe thermal influence and which is also most highly stressed is, of course, the die. Other parts which experience high temperatures are the liner, dummy block and, in the cases where one is used, the mandrel.

The typical temperature ranges experienced by these components during extrusion are:

- Aluminium and its alloys: 400–500° C (750–930° F)
- Copper and copper alloys: 600–1100° C (1110–2010° F)
- Steel: 1100–1250° C (2010–2280° F)

An optimum choice of tool steel and correct heat treatment are essential in order to increase the life of extrusion dies and extrusion tooling components which are subjected to these severe thermal conditions.

Tool steel properties for extrusion dies and tooling

The properties profile required for the tool steel in different components of an extrusion press is fairly similar. However, the varying severity of the thermal environment means that the desirable heat-resisting properties of hot-work tool steel are required to greater or lesser extent in different press parts. The requisite properties profile is essentially as follow:

- Adequate resistance to wear at elevated temperatures (e.g. dies, liners, mandrels)
- Enhanced hot yield strength and hot hardness
- High level of temper resistance and resistance to softening at elevated temperatures
- Good compressive strength (e.g. dummy blocks) and bending strength (e.g. dies, mandrels) at high temperatures
- High creep strength
- Acceptable resistance to thermal fatigue cracking.

Uddeholm's tool steel product programme for extrusion dies and extrusion tooling components is presented at the end of this brochure. For press components and dies subjected to the highest temperature, we recommend:

- *ORVAR 2 Microdized*
- *QRO 90 SUPREME*
- *HOTVAR*
- *DIEVAR*

In general *ORVAR 2 Microdized* is used in normal applications involving moderate temperatures and stresses, e.g. dies and other tooling components for production of standard aluminium profiles. For more extreme conditions *QRO 90 SUPREME*, *HOTVAR* and *DIEVAR* are recommended; these are Uddeholm speciality grades characterized by an extreme combination of toughness, ductility and strength at elevated temperatures.

TEMPER RESISTANCE

Temper resistance can be assessed from the tempering curve for a hardened tool steel. In this, the hardness **at room temperature** is plotted against tempering temperature for given tempering time. Another method of presenting temper resistance data is to plot room temperature hardness against time at a given tempering temperature. The better the steel retains its hardness as

the temperature or the time increases, the better its temper resistance,

HOT STRENGTH AND HOT HARDNESS

In contrast to temper resistance, which is defined in terms of hardness at room temperature, hot strength and hot hardness refer to properties **at high temperature**. In general, improved temper resistance is associated with increased hot strength and hot hardness. It can be pointed out that good hot hardness and hot strength are important prerequisites for enhanced **wear resistance** at elevated temperatures. A high level of hot hardness and hot strength is also important in order to achieve adequate resistance to thermal fatigue cracking.

COMPRESSIVE STRENGTH AND BEND STRENGTH AT HIGH TEMPERATURE

The greater the level of hot strength or hot hardness for a tool steel then the greater is its elevated temperature bend strength and compressive strength. The improved hot compressive strength is reflected in figure 1 which shows the drop in hardness, from a given initial hardness, over 24 h for *ORVAR 2 Microdized* and *QRO 90 SUPREME* loaded in compression at 600°C (1110°F). It is clear, from comparison with the hardness decrease in the unloaded condition, that the mechanical stress accelerates the softening of the steel. *QRO 90 SUPREME* retains the same degree of superiority over *ORVAR 2 Microdized* irrespective of whether the steel is subjected to mechanical loading or not during holding at high temperature.

The high temperature bend strength is influenced by, apart from hot hardness, the toughness and ductility of the steel.

Hardness decrease HRC

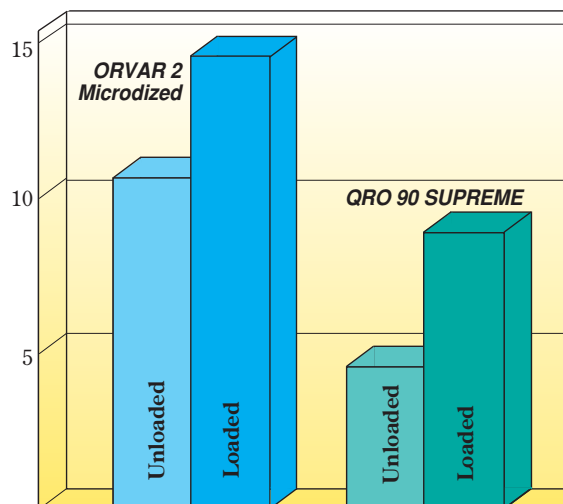

Fig. 1. Improved hot compressive strength.

DUCTILITY AND TOUGHNESS

The ductility of a die material quantifies the ability to resist plastic strain without cracking and is greatly influenced by the purity and the homogeneity of the material.

The toughness of the die material is the ability to resist loading without cracking at sharp notches or other stress raisers. The toughness depends on the die material and its heat treatment.

Uddeholm tool steels are manufactured to a very high degree of purity with regard to non-metallic inclusions. This ensures a level of toughness and ductility which is adequate for even the most exacting applications in extrusion, e.g. where dies and other tooling components are subjected to severe bending stresses at elevated temperature.

CREEP STRENGTH

Creep is the slow, time-dependent deformation of a metal subjected to loading at a level below what is normally required to plastically deform the metal at the temperature in question. A good creep strength improves the resistance to fracture at high temperatures and long time dependent loading.

Figure 2 demonstrates the qualitative comparison of critical steel properties and figure 3 the resistance to different failures.

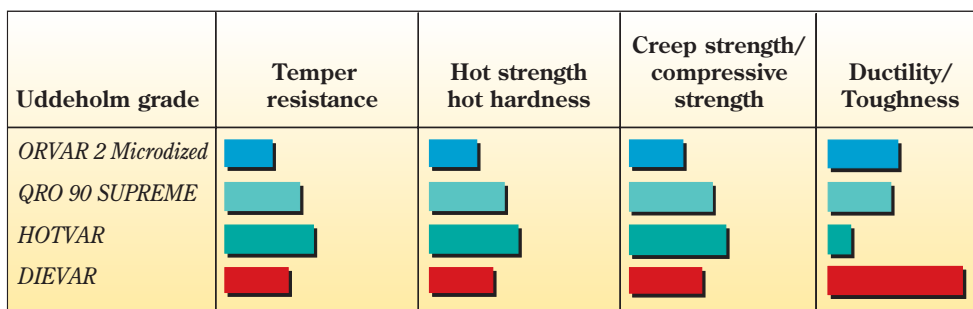

Fig. 2. Qualitative comparison of critical steel properties (the longer the bar, the better).

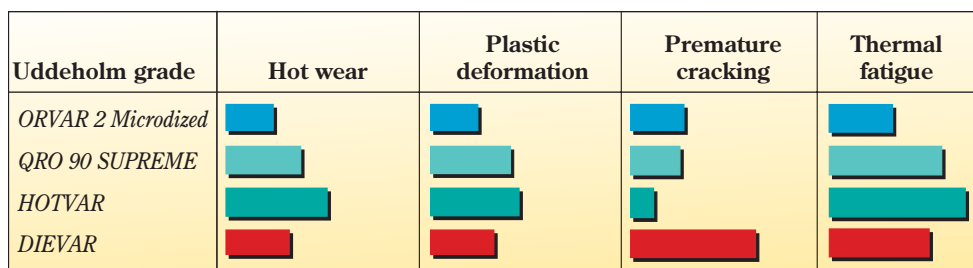

Fig. 3. Qualitative comparison of resistance to different tool failures (the longer the bar, the better).

Material selection for dies and extru- sion tooling parts

EXTRUSION DIES

An extrusion die is exposed to high temperatures derived not only from the heated billet but also from heat generated by deformation and friction. In addition, the die is subjected to high pressure and, in the area of the die land, considerable frictional forces. In aluminium extrusions, the hard oxide film, which forms instantaneously on the surface of the extruded metal, causes extensive abrasion of the die during service.

Die design

The die design and manufacture of extrusion dies is a highly specialized procedure requiring skilled die makers. It is necessary at the design stage to make proper allowance for shrinkage, elastic deformation, the nature of the profile section and the highly uneven velocity distribution when extruding complicated profiles (so that the profile remains more or less straight when extruded). The following criteria should be fulfilled during die design and manufacture:

- Very tight tolerances, so that the extruded profile does not have excessive weight per unit length (material yield)
- Correct die geometry from the beginning, thereby avoiding expensive reworking
- Carefully finished land surface such that the profile surface is acceptable
- Proper design, choice of die steel, heat treatment etc., giving maximum die life
- Rational production resulting in low die-manufacturing costs.

Factors determining die life

The stresses experienced by an extrusion die in service are both mechanical and thermal in origin. However, the thermal stresses arising from temperature differences are generally quite moderate in extrusion, where the temperature changes occur only fairly slowly. Hence, thermal fatigue cracks develop more gradually in extrusion than in other presses where hot work steels are used and where the temperature cycles are much more severe e.g. die casting. On the other hand, wear is very pronounced in extrusion, since the process involves sliding contact between the die steel and the metal being extruded.

Die life is therefore finite and is limited by (in order of importance):

- Wear
- Plastic deformation or cracking
- Identification
- Stability of support tooling
- Formation of thermal fatigue cracks.

The second point above deserves comment. Plastic deformation or even cracking of dies can occur particularly when extruding very complicated profiles through dies with high tongue ratios. In this case, the very great stress on the tongue combined with the locally high temperature can cause bending; in some instances, the tongue can actually break off if the transverse toughness of the steel is inadequate.

A tool steel with good hot strength and sufficient transverse toughness is a must for dies with high tongue ratios.

Improvement of wear resistance

Hot work tool steels are amenable to nitriding which produces a hard, wear-resistant surface layer. Nitriding is usually effected via salt-bath treatment, e.g. Tufftriding, and a given extrusion die can be treated many times until it is considered worn out. Nitriding of extrusion dies not only improves wear resistance but also reduces friction.

In the context of wear resistance, the temper resistance, hot strength and hot hardness of the steel are all important. In the region of contact between die and extruded metal, considerable deformational and frictional heat is developed and high temperatures are experienced. Appreciable wear will thus result if the temperature become so high that the surface of the die steel in the land region softens extensively. In the case of a nitrided die, the underlying steel can not, under such circumstances, give proper support to the nitrided layer which will wear more rapidly than usual.

Tool steel selection for dies

Standard dies for aluminium extrusion are made from *ORVAR 2 Microdized*, heat treated to 45–50 HRC and then nitrided/nitrocarburized, usually via Tufftriding or some similar treatment. The nitrided layer is up to 0,1 mm (0,004 inch) thick and has a surface hardness exceeding 1000 HV.

For pressing high strength aircraft alloys, it is important that the die material exhibits adequate transverse toughness in view of the very high pressures required for extrusion, which can otherwise be sufficient to fracture the die.

For dies with high tongue ratios and for producing complicated profiles, using *QRO 90 SU-PREME* will usually resulting considerably better life than W.-Nr. 1.2344 (AISI H13 type) steel even

for aluminium extrusion. Such dies are characterized by excessive heat generation in the land area and the superior hot strength/hot hardness of *QRO 90 SUPREME* engenders enhanced resistance to wear and bending/breakage. Practice has shown that *QRO 90 SUPREME* can be used for tongue ratios up to 6:1 whereas W.-Nr. 1.2344 (AISI H13 type) steel is limited to about 3:1 maximum. In addition, the superior wear resistance of *QRO 90 SUPREME* renders it eminently suitable for long-run aluminium dies.

QRO 90 SUPREME is also recommended for less complicated dies in extrusion of copper alloys and other metals and alloys, which are extruded at higher temperatures than aluminium.

HOTVAR is a further development of *QRO 90 SUPREME* and can be hardened to 58 HRC giving a very good hot wear resistance.

DIEVAR is a hot work tool steel suitable when premature cracks and heat checking are the dominating failure mechanisms. Also, in combination with other failure mechanisms as hot wear and plastic deformation *DIEVAR* offers potential solutions for an improved tooling economy.



Coated die.

STEMS

Stems are subjected to high pressure during extrusion but their working temperature is relatively low (not in contact with billet). A stem should not bend or otherwise deform at the temperature of operation.

ORVAR 2 Microdized is a suitable tool steel for stems (46–50 HRC), independent of what material is to be extruded.



Dummy blocks.

DUMMY BLOCKS

The dummy block physically separates the stem from the billet and, as such, has two basic functions:

- to protect the stem
- to prevent backwards “leakage” of the metal being extruded.

Exchangeable dummy blocks have been used for many years in all types of extrusion applications. The disc-like dummy block is changed after each billet and a number of blocks are kept in circulation. For extrusion of copper, copper alloys and steel, an exchangeable dummy block is always used (high temperature, dummy block must cool between billets). However, the **fixed dummy block** has become more and more popular for aluminium extrusion. This comprises two parts, a “male” and a “female”; the male is coupled to the female which in turn is fixed to the stem. Fixed dummy blocks are not changed between billets.

The fixed type of dummy block has the advantages of:

- improved productivity
- better yield
- superior surface finish of the extruded profile.



Stem.

Since both types of dummy block are subjected simultaneously to high pressure and temperature, the tool steel used for these components is required to exhibit:

- high level of hot strength/hot hardness
- good temper resistance
- good resistance to plastic deformation via creep.

Uddeholm recommend *QRO 90 SUPREME* for both exchangeable and fixed dummy blocks in all extrusion applications. The superior hot strength and hot hardness of this grade result in considerable increases in life.

One important function of the dummy block is to expand more or less elastically during the forward part of the cycle so as to tighten against the liner and prevent backward metal leakage. It is important that the yield stress of the steel is not exceeded during the expansion phase resulting in plastic deformation. High forces would be required to release the dummy block on its return phase, increasing the risk of movement in the liner. The relevant stress-strain curve is that at the actual working temperature of the dummy block. Hence, the better the hot yield strength of the tool steel, the better the chance of not exceeding the elastic limit during service and the lower the risk for permanent deformation of the dummy block. In a similar vein, the dummy block should not creep

excessively during service, i.e. should exhibit as little slow, permanent deformation as possible at loads below the elastic limit.

From the previous discussion of properties of hot work tool steels, it will be clear that *QRO 90 SUPREME*, with its high level of hot strength, good creep strength and relative good ductility/toughness is the natural choice for all dummy-block applications irrespective of the metal being extruded.

MANDRELS

Mandrels normally find application for extrusion of steel and copper tube.

Mandrels are subjected to severe operating conditions and the tool steel used to make them should possess:

- high strength at elevated temperatures
- good temper resistance

i.e. the same properties profile as for dummy blocks. For thin mandrels, resistance to bending at elevated temperatures is important. Hence, *QRO 90 SUPREME* will give superior mandrel life in most applications.

CONTAINERS

Containers can be built in two or three parts. A two-part container consists of a mantle and a liner, while a three-part one comprises a mantle, an intermediate liner and a liner proper.

The function of the container is to take up the hydrostatic and tangential stresses derived from



Containers.



the extrusion force. Nowhere in the container should these stresses exceed the elastic limit, i.e. the working stress range is similar to that for a dummy block with the qualification that the liner and the mantle are at different temperatures and will thus be characterized by different stress-strain curves.

If the elastic limit is exceeded for the steel in the mantle, the whole container will deform plastically to an extent that it may go out of tolerance. In extreme loading situation, it is not infeasible that the entire container can crack. Containers subjected to heavy loads are thus normally built in three parts. While this is obviously more expensive, it does give the advantage that the stress levels in each individual part are reduced appreciably at a given extrusion pressure, when compared with a two-part container.

MANTLE

Prehardened tool steel such as *IMPAX SUPREME* is normally used for the mantle (hardness approx. 310 HB).

For highly-stressed containers, *ORVAR 2 Microdized* at 37–43 HRC is a better choice. Compared with prehardened, quenched-and-tempered steel, *ORVAR 2 Microdized* exhibits superior temper resistance and hot strength. With *ORVAR 2 Microdized* as mantle material, there is virtually no chance of the mantle softening during service to the extent that the whole container suffers permanent deformation.

INTERMEDIATE LINER

The intermediate liner, when one is used, is made either in *IMPAX SUPREME* (approx. 310 HB) or, for more highly-stressed container, *ORVAR 2 Microdized* (37–43 HRC).

LINER

ORVAR 2 Microdized hardened and tempered to 44–48 HRC is normally used as a liner material in aluminium extrusion. For more difficult aluminium alloys, *QRO 90 SUPREME* is recommended. *QRO 90 SUPREME* and *DIEVAR* have also given excellent results in liners for extrusion of copper alloys.

SUPPORTING TOOLS

The die is positioned in a die ring, which in turn is attached to and is supported by one or more holder parts such as die rings, bolsters, wedge blocks etc. No problems are normally encountered with these parts in the extrusion of simple profiles; for more complicated shapes, however, it can be difficult to arrange for adequate support for the die. If there is any risk for overloading of the support tooling, it is important to select a tool steel with adequate hardness at the working temperature. In general, *ORVAR 2 Microdized* is used for die rings and *ALVAR 14* for bolsters. Other support tools such as wedge blocks and die heads can, as long as the service temperature is low, be made in prehardened *IMPAX SUPREME*.

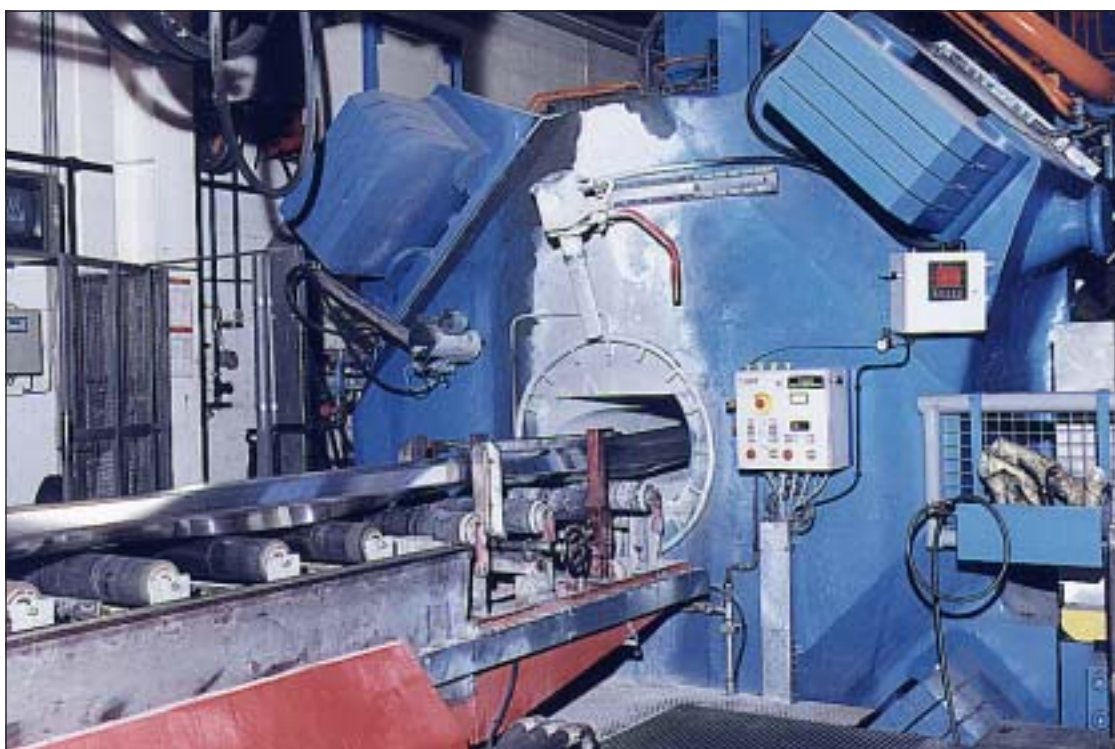

Extrusion press at Hydro Raufoss Automotive, Raufoss.

Manufacturing of dies and tooling

The machinability and heat treatment characteristics of the tool steel are significant parameters influencing the relative ease of manufacture of extrusion dies and extrusion tooling components.

MACHINABILITY

Uddeholm hot work tool steels, *ORVAR 2 Microdized*, *QRO 90 SUPREME* and *HOTVAR* are characterized by a high degree of freedom from oxide inclusions and an annealed microstructure consisting of a very even distribution of small carbides. The annealed hardness is low, 180–210 HB. These features are concomitant with a good machinability in the annealed condition. Advanced process control ensures that the variation in machining characteristics is minimal from batch to batch. *DIEVAR*'s extreme microcleanliness and low hardness (~160 HB) make the machinability less competitive compared to the steels mentioned above.

Uddeholm's product information brochures for *ORVAR 2 Microdized*, *QRO 90 SUPREME*, *HOTVAR* and *DIEVAR* give detailed information pertaining to machining of these products. Other Uddeholm brochures worth consulting in the context of die/tooling manufacture are: "Grinding of Tool Steel", "EDM (spark-erosion) of Tool Steel" and "Welding of Tool Steel".

HEAT TREATMENT

Hot work tool steels used for extrusion dies and tooling are normally supplied in the annealed condition. After machining, the tool/die must be heat treated in order that the steel develops its optimum combination of hardness, toughness and heat resistance. These properties are controlled through proper choice of austenitizing temperature, cooling conditions during hardening and tempering temperature/time.

More information is given in the product brochures and in the information brochure "Heat treatment of Tool Steel".



Manufacturing of dies (SAPA, Sweden).



Tool steel product programme for extrusion industry

Product description

<i>ORVAR 2 Microdized</i> W.-Nr. 1.2344 (AISI H13)	A Cr-Mo-V-alloyed hot-work steel with good high temperature strength. Recommended in most cases for tooling components and dies in aluminium extrusion which come into direct contact with the hot billet.
<i>QRO 90 SUPREME</i>	A premium hot work steel with very good strength and hot hardness at elevated temperatures. Recommended for all types of extrusion tooling, subjected to maximum working temperatures.
<i>HOTVAR</i>	A premium hot work steel with very good high-temperature properties. Can be hardened and tempered to 58 HRC giving an outstanding hot wear resistance. Recommended for dies which are not to be nitrided.
<i>DIEVAR</i>	A premium Cr-Mo-V hot work steel with good high temperature strength and excellent toughness and ductility in all directions. Recommended in dies and extrusion components where the demands on toughness and ductility are the highest.
<i>ALVAR 14</i> W.-Nr. 1.2714	Cr-Ni-Mo-alloyed hot work steel. Recommended for support tooling in extrusion, e.g. bolsters and wedge blocks.
<i>IMPAX SUPREME</i> W.-Nr. 1.2738 (AISI P20)	Prehardened Ni-Cr-Mo-alloyed steel supplied at approx. 310 HB, with good machinability. Suitable for wedge blocks and other support tools, mantles and intermediate liners, at lower temperature.

Chemical composition

Uddeholm grade	Approximate analyses, %							Delivery hardness HB
	C	Si	Mn	Cr	Mo	V	Ni	
<i>ORVAR 2 Microdized</i>	0,39	1,0	0,4	5,3	1,3	0,9	–	Annealed ~180
<i>QRO 90 SUPREME</i>	0,38	0,3	0,8	2,6	2,3	0,9	–	Annealed ~180
<i>HOTVAR</i>	0,55	1,0	0,8	2,6	2,3	0,9	–	~210
<i>DIEVAR</i>	Cr-Mo-V alloyed hot work tool steel							~160
<i>ALVAR 14</i>	0,55	0,3	0,7	1,1	0,5	0,1	1,7	Annealed ≤250
<i>IMPAX SUPREME</i>	0,37	0,3	1,4	2,0	0,2	–	1,0	Pre-hardened ~310

Extrusion tooling components from Hagfors Mekaniska Verkstad (HMV)

Uddeholm can offer a wide range of services from the subsidiary HMV AB to the extrusion industry. HMV AB is certified according to ISO 9002 and every component or service is well documented. HMV AB have modern CNC-machines and use the latest Information Technology to serve its customers.

HMV AB started in the beginning of 80's to serve the Extrusion industry and is market leader in the Nordic countries.

Following base-services can be offered:

- Manufacture of **new containers** and **renovation** of used containers including fitting of liners.
- We can also fit and/or renovate **pre-heating elements**.
- Manufacture of exchangeable or fixed **dummy blocks**.
- Manufacture of **stems** from forged stock.
- Manufacture of **mandrels**.
- Manufacture of **holders, bolsters, sub-bolsters** etc. All conceivable types can be made.
- Cutting and pre-machining of die blanks.



*CNC-turning of
dummy block in heat
treated condition.*

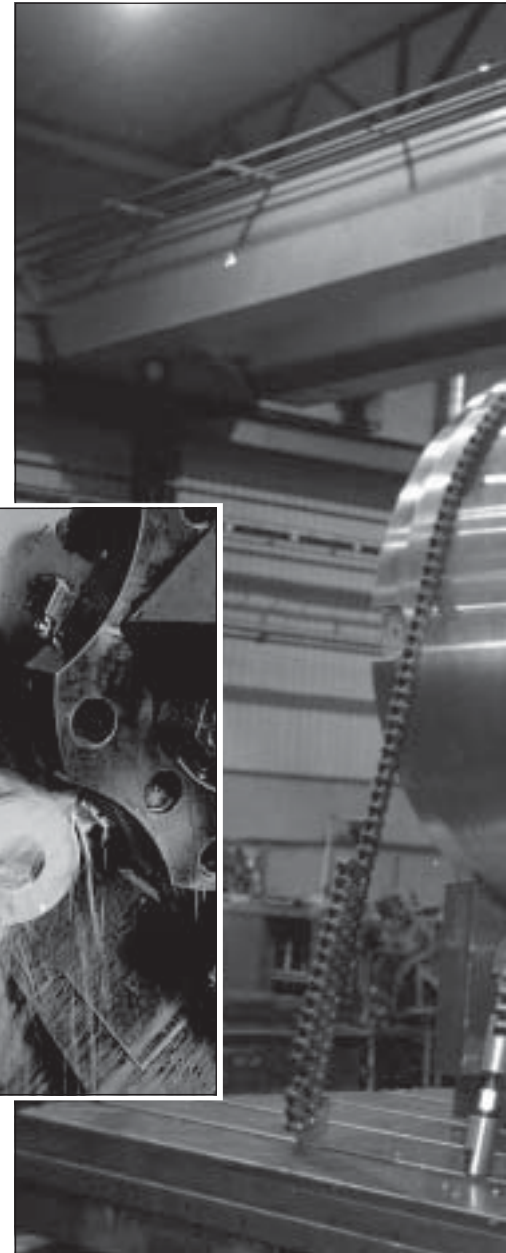

Shrinking of liner.



ISO 9002 certified.

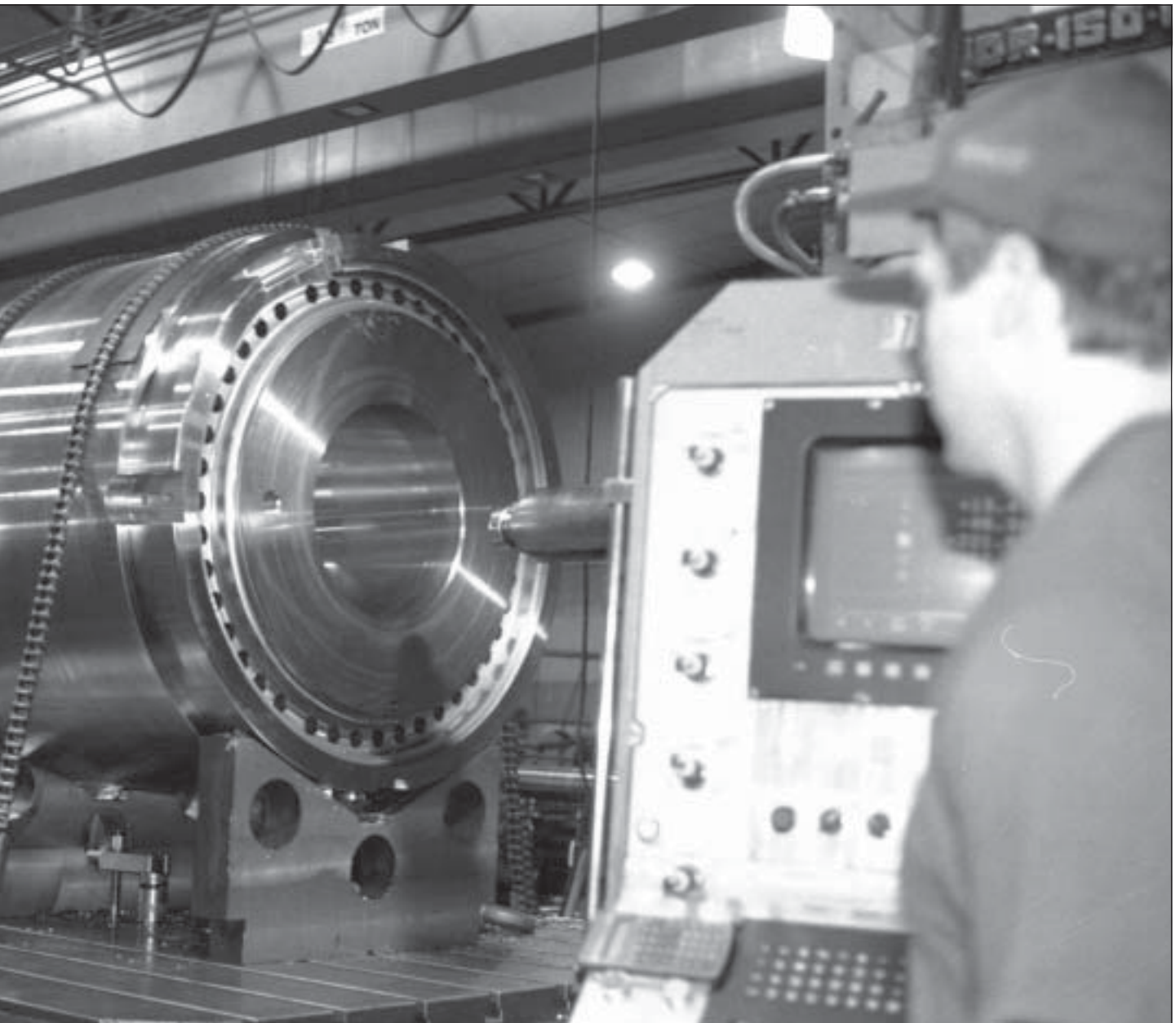

Production of a new container at Hagfors Mekaniska Verkstad AB.

The proximity to Uddeholm's central business stock guarantees that the optimum steel with the correct dimension is always available for direct use which also reduce the lead-time.

Heat treatment is always performed according to Uddeholm specification to guarantee best performance on the component.

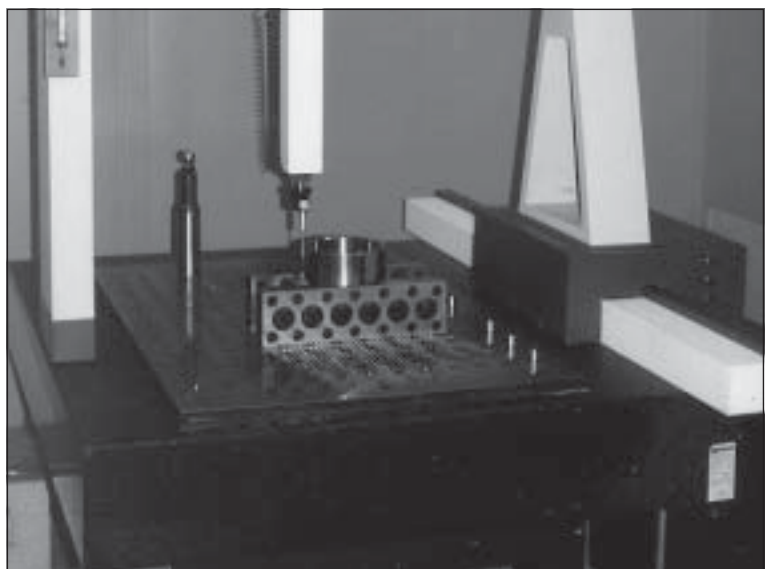

Final control in a coordinate measuring machine.

Steels and hardness selection for different extrusion applications

Tooling component	E X T R U D E D M A T E R I A L		
	Aluminium/magnesium	Copper alloys	Steel
Support tools (at lower temperature)	<i>IMPAX SUPREME</i> ~310 HB	<i>IMPAX SUPREME</i> ~310 HB	<i>IMPAX SUPREME</i> ~310 HB
Wedge block	<i>IMPAX SUPREME</i> ~310 HB <i>ALVAR 14</i> 300–400 HB	<i>IMPAX SUPREME</i> ~310 HB <i>ALVAR 14</i> 300–400 HB	<i>IMPAX SUPREME</i> ~310 HB <i>ALVAR 14</i> 300–400 HB
Bolster	<i>ALVAR 14</i> ~45 HRC	<i>ALVAR 14</i> ~45 HRC	<i>ALVAR 14</i> ~45 HRC
Die ring	<i>ORVAR 2 Microdized</i> 40–44 HRC	<i>QRO 90 SUPREME</i> 40–44 HRC	<i>QRO 90 SUPREME</i> 40–44 HRC
Die	<i>ORVAR 2 Microdized</i> 45–50 HRC <i>DIEVAR</i> 46–52 HRC <i>QRO 90 SUPREME</i> 45–50 HRC <i>HOTVAR</i> 54–58 HRC	<i>QRO 90 SUPREME</i> 45–49 HRC	<i>QRO 90 SUPREME</i> 44–46 HRC
Mantle	<i>IMPAX SUPREME</i> ~310 HB <i>ORVAR 2 Microdized</i> 37–43 HRC	<i>IMPAX SUPREME</i> ~310 HB <i>ORVAR 2 Microdized</i> 37–43 HRC	<i>IMPAX SUPREME</i> ~310 HB <i>ORVAR 2 Microdized</i> 37–43 HRC
Intermediate liner	<i>IMPAX SUPREME</i> ~310 HB <i>ORVAR 2 Microdized</i> 37–43 HRC	<i>IMPAX SUPREME</i> ~310 HB <i>ORVAR 2 Microdized</i> 37–43 HRC	<i>IMPAX SUPREME</i> ~310 HB <i>ORVAR 2 Microdized</i> 37–43 HRC
Liner	<i>ORVAR 2 Microdized</i> 44–48 HRC <i>QRO 90 SUPREME</i> 44–48 HRC <i>DIEVAR</i> 44–50 HRC	<i>QRO 90 SUPREME</i> 44–48 HRC <i>DIEVAR</i> 44–50 HRC	<i>ORVAR 2 Microdized</i> 44–48 HRC
Dummy block	<i>QRO 90 SUPREME</i> 44–48 HRC <i>DIEVAR</i> 46–52 HRC	<i>QRO 90 SUPREME</i> 44–48 HRC	<i>QRO 90 SUPREME</i> 44–48 HRC
Fasteners for fixed dummy block	<i>IMPAX SUPREME</i> ~310 HB		
Stem	<i>ORVAR 2 Microdized</i> 46–50 HRC	<i>ORVAR 2 Microdized</i> 46–50 HRC	<i>ORVAR 2 Microdized</i> 46–50 HRC
Mandrel	<i>ORVAR 2 Microdized</i> 46–50 HRC <i>QRO 90 SUPREME</i> 46–49 HRC	<i>QRO 90 SUPREME</i> 45–49 HRC <i>DIEVAR</i> 46–52 HRC	<i>QRO 90 SUPREME</i> 45–49 HRC

UDDEHOLM EUROPE

AUSTRIA

UDDEHOLM
Hansaallee 321
D-40549 Düsseldorf
Telephone: +49 211 535 10
Telefax: +49 211 535 12 80

BELGIUM

UDDEHOLM N.V.
Waterstraat 4
B-9160 Lokeren
Telephone: +32 9 349 11 00
Telefax: +32 9 349 11 11

CROATIA

BOHLER UDDEHOLM Zagreb
d.o.o za trgovinu
Zitnjak b.b
10000 Zagreb
Telephone: +385 1 2459 301
Telefax: +385 1 2406 790

CZECHIA

BOHLER UDDEHOLM CZ s.r.o.
Division Uddeholm
U silnice 949
161 00 Praha 6 Ruzyne
Czech Republic
Telephone: +420 233 029 850,8
Telefax: +420 233 029 859

DENMARK

UDDEHOLM A/S
Kokmose 8, Bramdrupdam
DK-6000 Kolding
Telephone: +45 75 51 70 66
Telefax: +45 75 51 70 44

ESTONIA

UDDEHOLM TOOLING AB
Silikatsiidi 7
EE-0012 Tallinn
Telephone: +372 655 9180
Telefax: +372 655 9181

FINLAND

OY UDDEHOLM AB
Ritakuja 1, PL 57,
FIN-01741 VANTAA
Telephone: +358 9 290 490
Telefax: +358 9 2904 9249

FRANCE

UDDEHOLM S.A.
12 Rue Mercier, Z.I. de Mitry-Compans
F-77297 Mitry Mory Cedex
Telephone: +33 (0)1 60 93 80 10
Telefax: +33 (0)1 60 93 80 01

Branch office

UDDEHOLM S.A.
77bis, rue de Vesoul
La Nef aux Métiers
F-25000 Besançon
Telephone: +33 381 53 12 19
Telefax: +33 381 53 13 20

GERMANY

UDDEHOLM
Hansaallee 321
D-40549 Düsseldorf
Telephone: +49 211 535 10
Telefax: +49 211 535 12 80

Branch offices

UDDEHOLM
Falkenstraße 21
D-65812 Bad Soden/TS.
Telephone: +49 6196 659 60
Telefax: +49 6196 659 625

UDDEHOLM

Albstraße 10
D-73765 Neuhausen
Telephone: +49 715 898 65-0
Telefax: +49 715 898 65-25

GREAT BRITAIN, IRELAND

UDDEHOLM UK LIMITED
European Business Park
Taylors Lane, Oldbury
West Midlands B69 2BN
Telephone: +44 121 552 55 11
Telefax: +44 121 544 29 11
Dublin Telephone: +353 1 45 14 01

GREECE

UDDEHOLM STEEL TRADING
COMPANY
20, Athinon Street
G-Piraeus 18540
Telephone: +30 2 10 41 72 109/41 29 820
Telefax: +30 2 10 41 72 767

SKLERO S.A.

Steel Trading Comp. and
Hardening Shop
Frixou 11/Nikif. Ouranou
G-54627 Thessaloniki
Telephone: +30 31 51 46 77
Telefax +30 31 54 12 50

HUNGARY

UDDEHOLM TOOLING/BOK
Dunaharaszti, Jedlik Ányos út 25
H-2331 Dunaharaszti 1.Pf. 110
Telephone/Telefax: +36 24 492 690

ITALY

UDDEHOLM Italia S.p.A.
Via Palizzi, 90
I-20157 Milano
Telephone: +39 02 35 79 41
Telefax: +39 02 390 024 82

LATVIA

UDDEHOLM TOOLING AB
Deglava street 50
LV-1035 Riga
Telephone: +371 7 701 983, -981, -982
Telefax: +371 7 701 984

LITHUANIA

UDDEHOLM TOOLING AB
BE PLIENAS IR METALAI
T. Masiulio 18b
LT-3014 Kaunas
Telephone: +370 37 370613, -669
Telefax: +370 37 370300

THE NETHERLANDS

UDDEHOLM B.V.
Isolatorweg 30
NL-1014 AS Amsterdam
Telephone: +31 20 581 71 11
Telefax: +31 20 684 86 13

NORWAY

UDDEHOLM A/S
Jernkroken 18
Postboks 85, Kalbakken
N-0902 Oslo
Telephone: +47 22 91 80 00
Telefax: +47 22 91 80 01

POLAND

INTER STAL CENTRUM
Sp. z. o.o./Co. Ltd.
ul. Kolejowa 291, Dziekanów Polski
PL-05-092 Lomianki
Telephone: +48 22 429 2260
Telefax: +48 22 429 2266

PORTUGAL

F RAMADA Aços e Industrias S.A.
P.O. Box 10
P-3881 Ovar Codex
Telephone: +351 56 58 61 11
Telefax: +351 56 58 60 24

ROMANIA

BÖHLER Romania SRL
Uddeholm Branch
Str. Atomistilor Nr 14A
077125 Magurele Jud Ilfov
Telephone: +40 214 575007
Telefax: +40 214 574212

RUSSIA

UDDEHOLM TOOLING CIS
25 A Bolshoy pr PS
197198 St. Petersburg
Telephone: +7 812 233 9683
Telefax: +7 812 232 4679

SLOVAKIA

UDDEHOLM Slovakia
Nástrojové ocele, s.r.o
KRÁCINY 2
036 01 Martin
Telephone: +421 842 4 300 823
Telefax: +421 842 4 224 028

SLOVENIA

UDDEHOLM Italia S.p.A.
Via Palizzi, 90
I-20157 Milano
Telephone: +39 02 35 79 41
Telefax: +39 02 390 024 82

SPAIN

UDDEHOLM
Guifré 690-692
E-08918 Badalona, Barcelona
Telephone: +34 93 460 1227
Telefax: +34 93 460 0558

Branch office

UDDEHOLM
Barrio San Martin de Artega, 132
Pol.Ind. Torrelarragoiti
E-48170 Zamudio
(Bizkaia)
Telephone: +34 94 452 13 03
Telefax: +34 94 452 13 58

SWEDEN

UDDEHOLM TOOLING
SVENSKA AB
Aminogatan 25
SE-431 53 Mölndal
Telephone: +46 31 67 98 50
Telefax: +46 31 27 02 94

SWITZERLAND

HERTSCH & CIE AG
General Wille Strasse 19
CH-8027 Zürich
Telephone: +41 1 208 16 66
Telefax: +41 1 201 46 15

UDDEHOLM NORTH AMERICA

USA

UDDEHOLM
4902 Tollview Drive
Rolling Meadows IL 60008
Telephone: +1 847 577 22 20
Telefax: +1 847 577 80 28

UDDEHOLM

548 Clayton Ct.,
Wood Dale IL 60191
Telephone: +1 630 350 10 00
Telefax: +1 630 350 08 80

UDDEHOLM

9331 Santa Fe Springs Road
Santa Fe Springs, CA 90670
Telephone: +1 562 946 65 03
Telefax: +1 562 946 77 21

UDDEHOLM

220 Cherry Street
Shrewbury, MA 01545
Telephone: +1 508 845 1066
Telefax: +1 508 845 3471

CANADA

UDDEHOLM LIMITED
2595 Meadowvale Blvd.
Mississauga, Ontario L5N 7Y3
Telephone: +1 905 812 9440
Telefax: +1 905 812 8659

MEXICO

ACEROS BOHLER UDDEHOLM,
S.A. de C.V.
Calle 8 No 2, Letra "C"
Fraccionamiento Industrial Alce Blanco
C.P. 52787 Naucalpan de Juarez
Estado de Mexico
Telephone: +52 55 9172 0242
Telefax: +52 55 5576 6837

UDDEHOLM

Lerdo de Tejada No.542
Colonia Las Villas
66420 San Nicolas de Los Garza, N.L.
Telephone: +52 8-352 5239
Telefax: +52 8-352 5356

UDDEHOLM SOUTH AMERICA

ARGENTINA

UDDEHOLM S.A
Mozart 40
1619-Centro Industrial Garin
Garin-Prov. Buenos Aires
Telephone: +54 332 744 4440
Telefax: +54 332 745 3222

BRAZIL

UDDEHOLM ACOS ESPECIAIS Ltda.
Estrada Yae Massumoto, 353
CEP 09842-160
Sao Bernardo do Campo - SP Brazil
Telephone: +55 11 4393 4560, -4554
Telefax: +55 11 4393 4561

UDDEHOLM SOUTH AFRICA

UDDEHOLM Africa (Pty) Ltd.
P.O. Box 539
ZA-1600 Isando/Johannesburg
Telephone: +27 11-974 2781
Telefax: +27 11-392 2486

UDDEHOLM AUSTRALIA

BOHLER-UDDEHOLM Australia
129-135 McCredie Road
Guildford NSW 2161
Private Bag 14
Telephone: +61 2 9681 3100
Telefax: +61 2 9632 6161

Branch offices

Sydney, Melbourne, Adelaide,
Brisbane, Perth, Newcastle,
Launceston, Albury, Townsville

ASSAB

ASSAB INTERNATIONAL

Skytteholmsvägen 2
P O Box 42
SE-171 11 Solna
Sweden
Telephone: +46 8 564 616 70
Telefax: +46 8 25 02 37

Subsidiaries

India, Iran, Turkey, United Arab
Emirates

Distributors in

Africa, Latin America, Middle East

ASSAB PACIFIC

ASSAB Pacific Pte. Ltd
171, Chin Swee Road
No. 07-02, San Centre
Singapore 169877
Telephone: +65 534 56 00
Telefax: +65 534 06 55

Subsidiaries

China, Hong Kong, Indonesia, Japan,
Korea, Malaysia, Philippine Islands,
Singapore, Taiwan, Thailand

When the first idea pops into your head, throughout the development process to the release of the new product, we'll be your partner. As the world's leading supplier of tooling materials and related services, we can be trusted. Meet us under the Uddeholm and ASSAB brands, wherever in the world you have your business.